

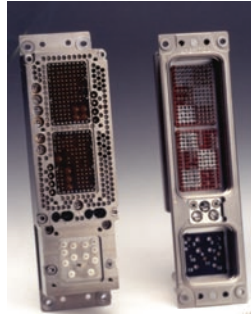

ARINC 600

ARINC 600 filter connectors are designed to meet or exceed all applicable requirements of the specification. These connectors are intermateable and interchangeable with the standard non-filtered connectors.



Material and Finishes	
Shell	Aluminum alloy
Insulator	High grade plastic/epoxy
Contacts	Copper alloy, gold plate
Grommet & Seal	Silicon base elastomer
Ground Plane	Brass, Silver Plate
Capacitor	Barium Titanate
Inductor	Ferrite bead

Part Number Description Code

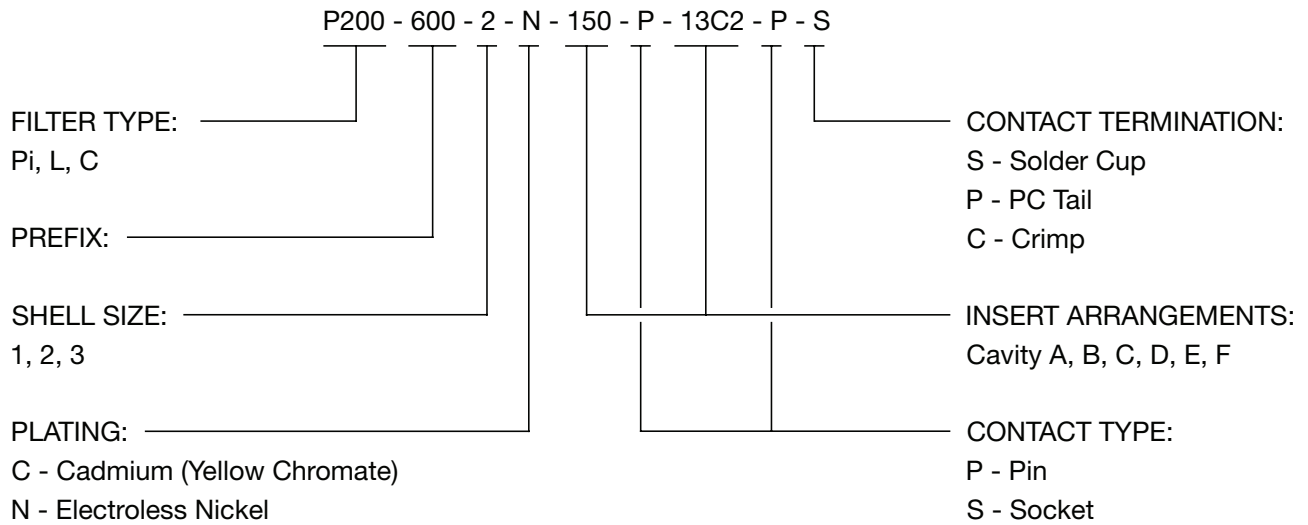

Insert Arrangements

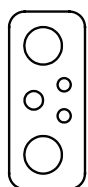

1 #12, 2 #16,
2 #5 Coax
5C2

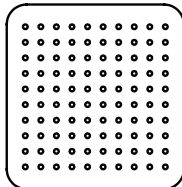

100 #22
100

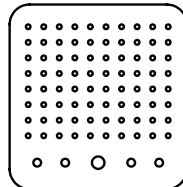

80 #22, 4 #20, 1 #16
85

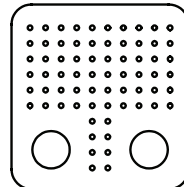

68 #22, 2 #8
68Q2

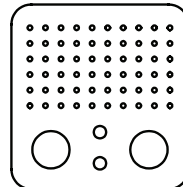

60 #22, 2 #16, 2 #8
62Q2

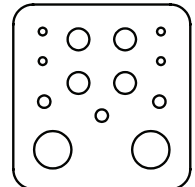

4 #20, 3 #16, 4 #12
11Q2

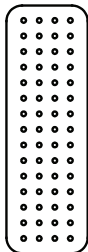

60 #22
60

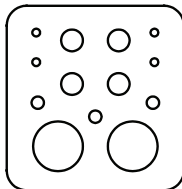

4 #20, 4 #12, 3 #16
2 #5 Coax
13C2

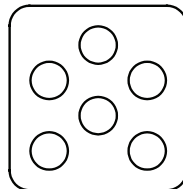

6 #8
Q6
Metallic Insert

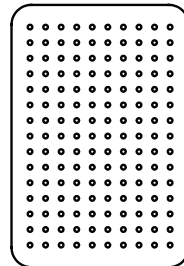

150 #22
150

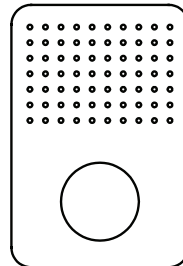

70 #22, 1 #1 Coax
150

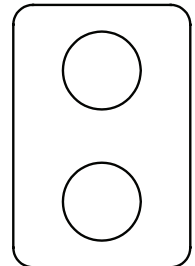

2 #1 Coax
C2

Sabritec provides specialty, enhanced performance connectors and cable assemblies and as such does not currently offer circular, rack and panel, or D-subminiature connectors that are listed on military standard Qualified Products Lists (QPL) per applicable detail specification sheets. Sabritec's connectors are fully intermateable with applicable QPL products and meet the applicable requirements of all military standards listed in this catalog.



ARINC 600

Shell Sizes 1-3

Shell Size 1

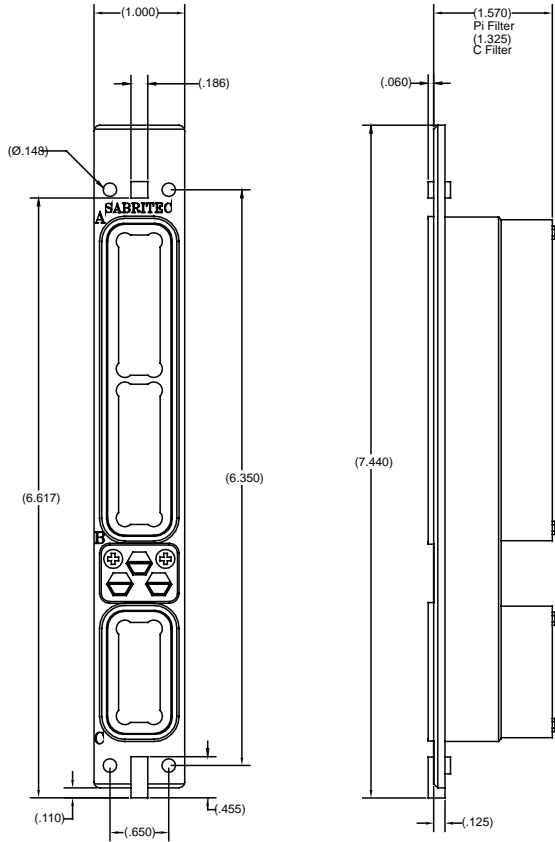

Shell Size 2

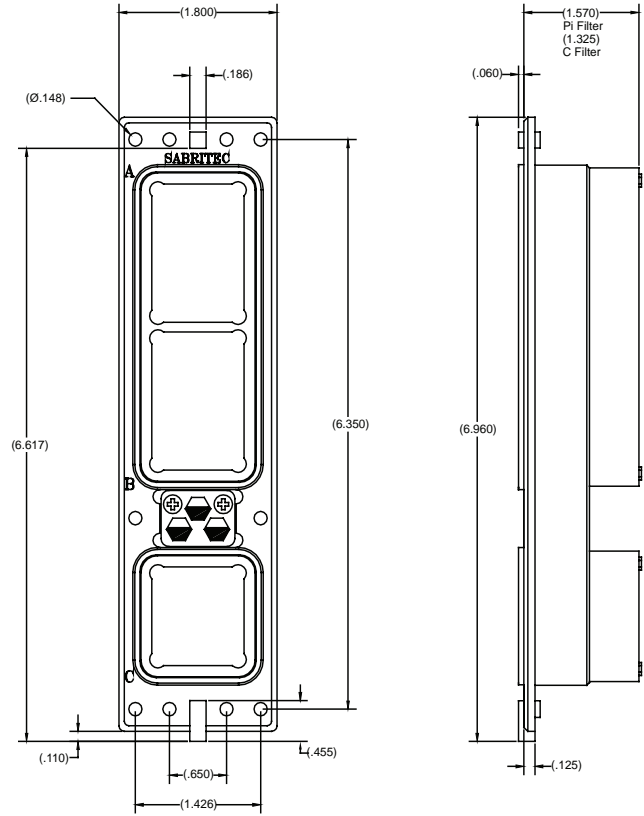

Shell Size 3

